

APPLITEC

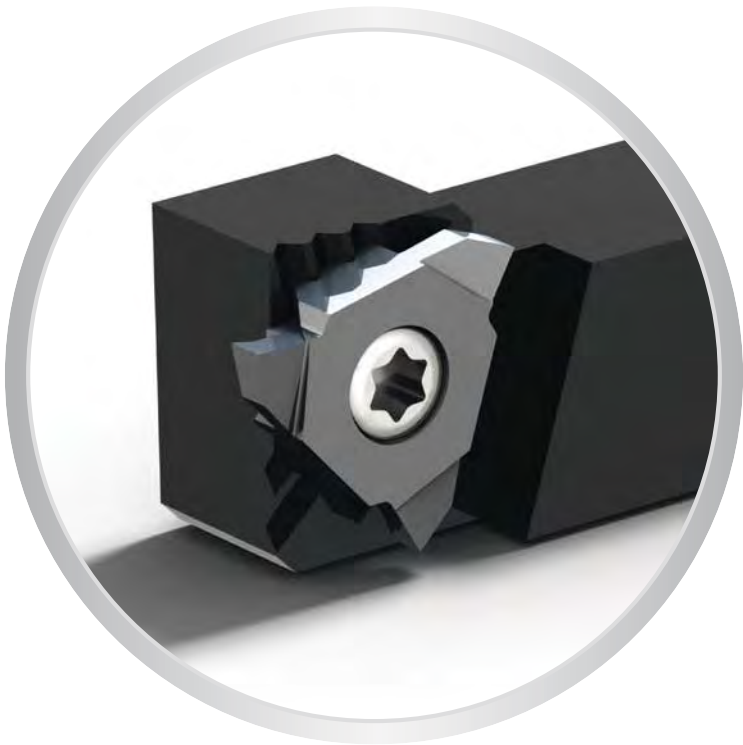

Nuances
Sorten
Grades

> 5.02

Conseils d'utilisation - Accessoires
Anwendungsempfehlungen - Zubehör
Application recommendations - Accessories



> 5.03

Porte-outils
Halter
Holders

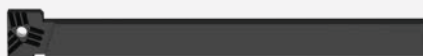

> 5.04

GX

Gorge de précision
Präzisionseinstechen
High precision grooving

DIN6799
& DIN471



> 5.05

FT

Tournage finition
Schlicht drehen
Fine turning

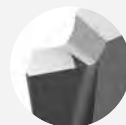

> 5.06

GT

Fonçage-tournage
Einstechen und drehen
Grooving and turning

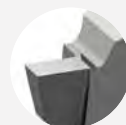

> 5.07

GTX

Fonçage-tournage avec coupe positive
Einstechen und drehen mit positivem Spanwinkel
Grooving and turning with positive cut

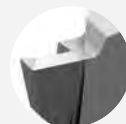

> 5.08

EP

Plaquettes ébauches
WSP-Rohlinge
Blank inserts

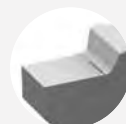

> 5.09

Rigid clamping system with the famous Applitec teeth clamping

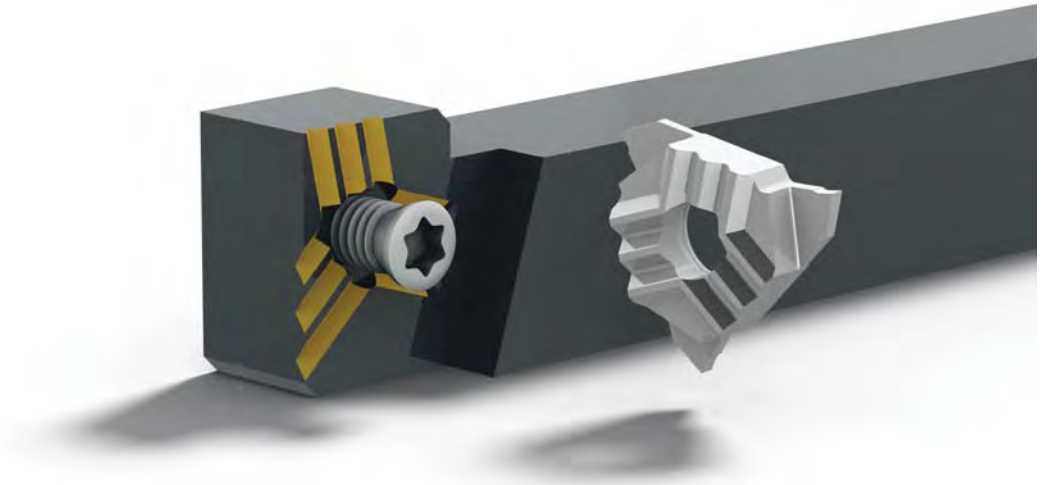

Nuances micro-grain à dureté élevée

Verschleissfeste Feinkornsorten

Wear resistant micro-grain grades

HTA

μK10 + revêtement PVD
μK10 + PVD Beschichtung
μK10 + PVD coating

- nuance très résistante à l'usure
- pour l'usinage en finition dans des conditions favorables des aciers, aciers inoxydables et alliages de titane

- sehr verschleissfeste Sorte
- für die Feinbearbeitung von Stahl, rostfreiem Stahl und Titanlegierungen bei guten Bearbeitungsbedingungen

- very wear resistant grade
- for light machining of steel, stainless steel and titanium alloys under favourable machining conditions

HN (μK10)

non revêtu
unbeschichtet
uncoated

- nuance micro-grain très résistante à l'usure
- recommandé pour l'usinage du laiton, de l'aluminium et du titane faiblement allié

- sehr verschleissfeste Feinkornsorte
- für die Bearbeitung von Messing und niedrig legiertem Aluminium und Titan empfehlenswert

- very wear resistant micro-grain grade
- suitable for the machining of brass and low alloyed aluminium and titanium

Paramètres de coupe indicatifs

Empfohlene Schnittwerte

Standard machining data

Matière Werkstoff Material		Tournage Drehen Turning		Foncer Einstechen Grooving	
		VC (m/min)	F (mm/U)	VC (m/min)	F (mm/U)
Acier de décolletage Automatenstahl Free-cutting steel	P	120 - 200	0.01 - 0.20	80 - 150	0.01 - 0.15
Acier Stahl Steel	P	< 600 N/mm ² 80 - 160	0.01 - 0.18	70 - 120	0.01 - 0.12
Acier Stahl Steel	P	< 800 N/mm ² 60 - 120	0.01 - 0.15	60 - 100	0.01 - 0.10
Acier Stahl Steel	P	> 800 N/mm ² 50 - 100	0.01 - 0.12	40 - 80	0.01 - 0.08
Acier inoxydable Rostfreistahl Stainless steel	M	60 - 120	0.01 - 0.15	60 - 100	0.01 - 0.08
Aluminium	N	180 - 800	0.01 - 0.30	150 - 300	0.01 - 0.20
Cuivre, laiton, bronze Kupfer, Messing, Bronze Copper, brass, bronze	N	100 - 500	0.01 - 0.30	100 - 300	0.01 - 0.20
Titane Titan Titanium	S	30 - 70	0.01 - 0.12	30 - 50	0.01 - 0.06

Accessoires

Zubehöre

Accessories

Porte-outils Halter Holders			Option Art. N°
T216-H...	V-M4X9-T15	C-T15	SET-NM-TX15

Recommandation de serrage
Drehmoment Empfehlung
Clamping recommendation

3.0 Nm



SET-NM-TX15

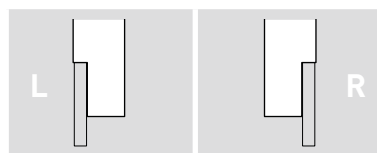
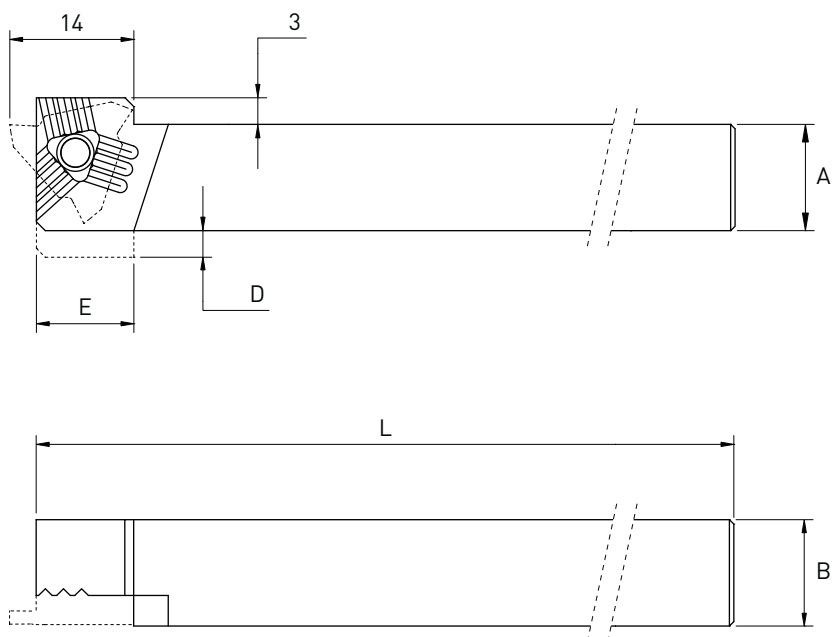

Chaque support est livré avec vis et clé.
 Jeder Halter wird mit Spannschraube(n)
 und Schlüssel geliefert.
 Screw(s) and key are included with each
 tool holder.

A	B	D	E	L	Art. N°	Art. N°
8	10	4	11	115	T216-H0810L	T216-H0810R
10	10	2	8	130	T216-H1010L	T216-H1010R
12	12	-	-	130	T216-H1212L	T216-H1212R
12	12	-	-	90	T216-H1212L-90	T216-H1212R-90
16	16	-	-	120	T216-H1616L	T216-H1616R
20	20	-	-	130	T216-H2020L	T216-H2020R

Plaquettes de gorge pour circlips

Einstechwendeplatte für Seegerring

Grooving inserts for retaining ring

GX

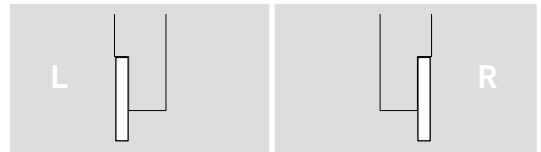
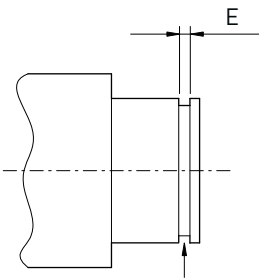
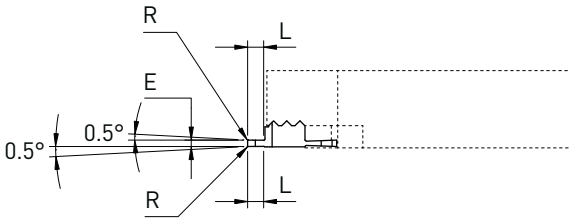
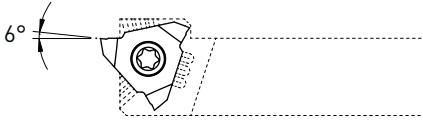

Selon DIN6799 et DIN471
Gemäss DIN6799 und DIN471
According to DIN6799 and DIN471

E ±0,01	L	R	L		R	
			Art. N°	HTA HN	Art. N°	HTA HN
0.26	0.8	0.03	T216L-GX026	■ ■	T216R-GX026	■ ■
0.36	0.8	0.03	T216L-GX036	■ ■	T216R-GX036	■ ■
0.46	0.8	0.03	T216L-GX046	■ ■	T216R-GX046	■ ■
0.50	1.5	0.03	T216L-GX050	■ ■	T216R-GX050	■ ■
0.57	1.5	0.03	T216L-GX057	■ ■	T216R-GX057	■ ■
0.67	1.5	0.03	T216L-GX067	■ ■	T216R-GX067	■ ■
0.77	2.0	0.03	T216L-GX077	■ ■	T216R-GX077	■ ■
0.87	2.0	0.03	T216L-GX087	■ ■	T216R-GX087	■ ■
0.97	2.5	0.03	T216L-GX097	■ ■	T216R-GX097	■ ■
1.00	2.5	0.03	T216L-GX100	■ ■	T216R-GX100	■ ■
1.10	2.5	0.03	T216L-GX110	■ ■	T216R-GX110	■ ■
1.20	2.5	0.03	T216L-GX120	■ ■	T216R-GX120	■ ■
1.30	2.5	0.03	T216L-GX130	■ ■	T216R-GX130	■ ■
1.50	2.5	0.03	T216L-GX150	■ ■	T216R-GX150	■ ■
1.60	2.5	0.03	T216L-GX160	■ ■	T216R-GX160	■ ■
1.85	2.5	0.03	T216L-GX185	■ ■	T216R-GX185	■ ■
2.00	2.5	0.03	T216L-GX200	■ ■	T216R-GX200	■ ■
2.50	2.5	0.03	T216L-GX250	■ ■	T216R-GX250	■ ■



TRIO-LINE

Tournage avant
Vorwärts drehen
Front turning

FT

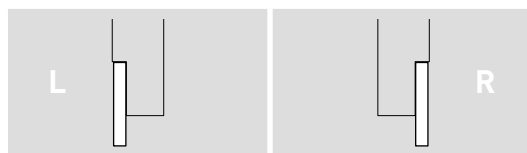
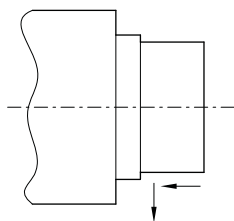
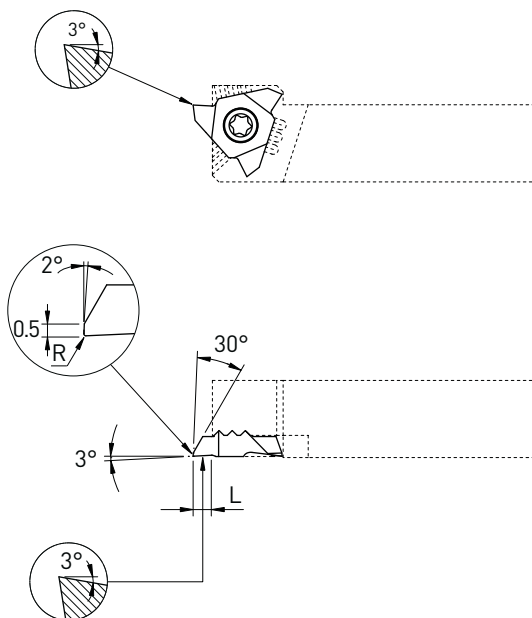

		L		R	
L	R	Art. N°	HTA HN	Art. N°	HTA HN
3.0	0.03	T216L-FT	■ ■	T216R-FT	■ ■
3.0	0.08	T216L-FT-R08	■ ■	T216R-FT-R08	■ ■

Fonçage-tournage

Einstecken und drehen

Grooving and turning

GT

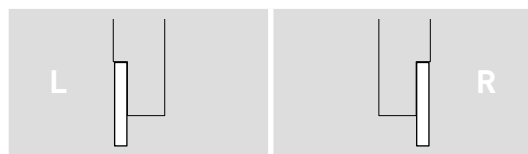
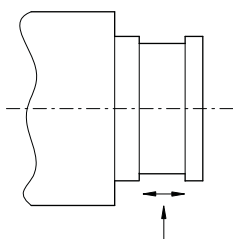
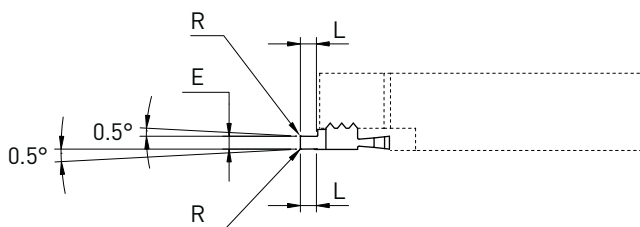
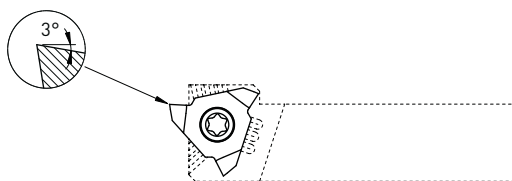

E	L	R	Art. N°	HTA		Art. N°	HN	
				■	■		■	■
0.5	1.5	0.03	T216L-GT050	■	■	T216R-GT050	■	■
1.0	2.5	0.03	T216L-GT100	■	■	T216R-GT100	■	■
1.0	2.5	0.08	T216L-GT100-R08	■	■	T216R-GT100-R08	■	■
1.5	2.5	0.03	T216L-GT150	■	■	T216R-GT150	■	■
1.5	2.5	0.08	T216L-GT150-R08	■	■	T216R-GT150-R08	■	■
1.5	2.5	0.15	T216L-GT150-R15	■	■	T216R-GT150-R15	■	■
2.0	2.5	0.03	T216L-GT200	■	■	T216R-GT200	■	■
2.0	2.5	0.08	T216L-GT200-R08	■	■	T216R-GT200-R08	■	■
2.0	2.5	0.15	T216L-GT200-R15	■	■	T216R-GT200-R15	■	■
2.5	2.5	0.15	T216L-GT250-R15	■	■	T216R-GT250-R15	■	■

TRIO-LINE

Fonçage-tournage
Einstecken und drehen
Grooving and turning

GTX

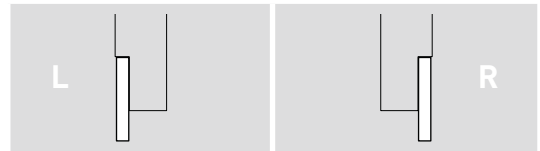
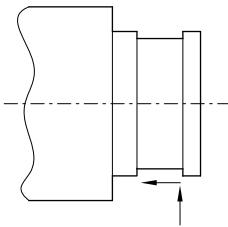
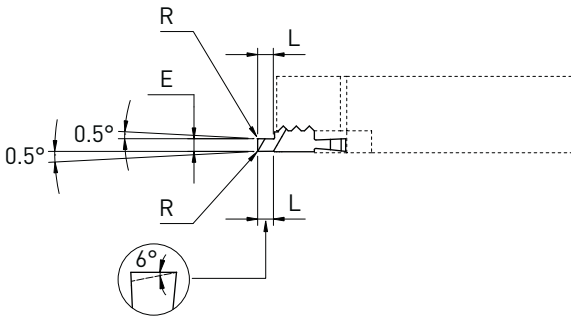
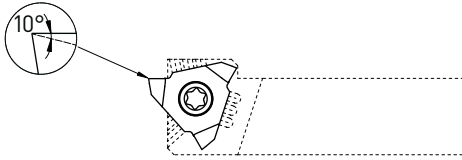

E	L	R	Art. N°	HTA		Art. N°	HN	
				HTA	HN		HTA	HN
1.0	2.5	0.03	T216L-GTX100	■	■	T216R-GTX100	■	■
1.0	2.5	0.08	T216L-GTX100-R08	■	■	T216R-GTX100-R08	■	■
1.5	2.5	0.03	T216L-GTX150	■	■	T216R-GTX150	■	■
1.5	2.5	0.08	T216L-GTX150-R08	■	■	T216R-GTX150-R08	■	■
1.5	2.5	0.15	T216L-GTX150-R15	■	■	T216R-GTX150-R15	■	■
2.0	2.5	0.03	T216L-GTX200	■	■	T216R-GTX200	■	■
2.0	2.5	0.08	T216L-GTX200-R08	■	■	T216R-GTX200-R08	■	■
2.0	2.5	0.15	T216L-GTX200-R15	■	■	T216R-GTX200-R15	■	■
2.5	2.5	0.15	T216L-GTX250-R15	■	■	T216R-GTX250-R15	■	■

- Plaquettes ébauches
- WSP-Rohlinge
- Blank inserts

EP

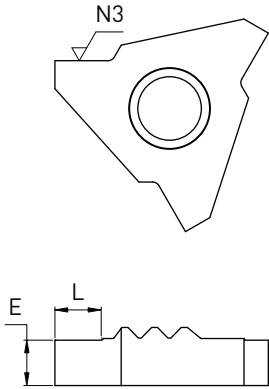

		L		R	
E	L	Art. N°	HTA HN	Art. N°	HTA HN
~3	3	T216L-EP	■	T216R-EP	■