

# ACCESSORIES

## ZUBEHÖR

## YEDEKLER



### CONTENTS / INHALT / İÇİNDEKİLER

ER-OZ Collet / ER-OZ Spannzanze ER-OZ Pens	128
ER Collet with Seal / ER Spannzanze mit Abdichtung für IK İçten Su Vermeli ER Pens	132
ER Tap Collet / ER Gewindebohrspannzanze ER Kılavuz Pensi	134
Collet for Hydraulic Chuck / Reduzierstück für Hydro-Dehnspannfutter Hidrolik Pensi	136
Collet for Milling Chuck / Spannzanze für Kraftspannfutter Pens GKS, Bilyalı Pens Başlığı için	136
Reduction for Coolant Feeder / Reduzierbuchse für Kühlmittelzuführung Redüksiyon, Dıştan Soğ. Takımlar için	137
Clamping Nut OZ-ER/ Spannmutter OZ-ER Kapak OZ-ER	138
Wrench / Hakenschlüssel Ay Anhatar	142
Tapping Collet / Einsatz mit Rutschkupplung Kılavuz Tutucu	144
Shrink Extension / Schrumpferlängerung Shrink Uzatma	146
Collet Chuck with Cylindrical Shank / Spannzanzenfutter mit Zylinderschaft Silindirik Şaftlı Pens Başlığı	147
Drill Chuck / Bohrfutter Supra Mandren	148
Pull Stud / Anzugsbolzen Çektirme Civatası	149
3D Edge Sensor / 3D-Kantentaster 3D Saatli Sıfırlama	154
Edge Finder / Kantentaster Elektronik Işıklı & Sesli Prop	155
Fast-mounting Assembly / Schnellmontageblock Üniversal Montaj Aparatı	156
Benchtop Tool Shelf / Tischwerkzeugregal Masaüstü Takım Sehpaları	157

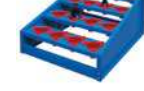

## ER Collet DIN 6499

ER Spannzange DIN 6499

ER Pens DIN 6499

Type  
ER

Form  
B

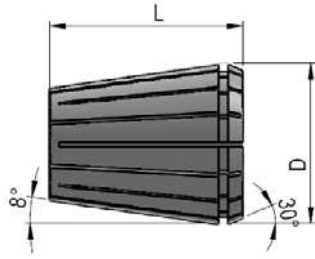

Order No. Bestell-Nr. Sipariş No.	Description   Bezeichnung   Açıklama Diameters   Durchmesser   Çaplar	D	L
4004E.Ø	<b>ER8 4004E</b> Ø 1 - 1,5 - 2 - 2,5 - 3 - 3,5 - 4 - 4,5 - 5	8,5	13,6
4008E.Ø	<b>ER11 4008E</b> Ø 1 - 1,5 - 2 - 2,5 - 3 - 3,5 - 4 - 4,5 - 5 - 5,5 - 6 - 6,5 - 7	11,5	18
426E.Ø	<b>ER16 426E</b> Ø 1 - 2 - 3 - 4 - 5 - 6 - 7 - 8 - 9 - 10	17	27,5
428E.Ø	<b>ER20 428E</b> Ø 1 - 2 - 3 - 4 - 5 - 6 - 7 - 8 - 9 - 10 - 11 - 12 - 13	21	31,5
430E.Ø	<b>ER25 430E</b> Ø 1 - 2 - 3 - 4 - 5 - 6 - 7 - 8 - 9 - 10 - 11 - 12 - 13 - 14 15 - 16	26	34
470E.Ø	<b>ER32 470E</b> Ø 1 - 2 - 3 - 4 - 5 - 6 - 7 - 8 - 9 - 10 - 11 - 12 - 13 - 14 15 - 16 - 17 - 18 - 19 - 20	33	40
472E.Ø	<b>ER40 472E</b> Ø 1 - 2 - 3 - 4 - 5 - 6 - 7 - 8 - 9 - 10 - 11 - 12 - 13 - 14 15 - 16 - 17 - 18 - 19 - 20 - 21 - 22 - 23 - 24 - 25 - 26	41	46



Collet Set  
Spannzangensatz  
Pens Seti

**OZ Collet DIN 6388**

OZ Spannzange DIN 6388

OZ Pens DIN 6388

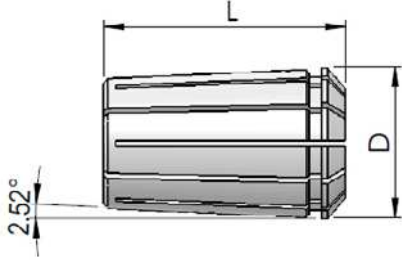
Type  
OZForm  
B

Order No. Bestell-Nr. Sipariş No.	Description   Bezeichnung   Açıklama Diameters   Durchmesser   Çaplar	D	L
415E.Ø	<b>OZ16 415E</b> Ø 2 - 3 - 4 - 5 - 6 - 7 - 8 - 9 - 10 - 11 - 12 - 13 - 14 - 15 16	25,5	40
462E.Ø	<b>OZ25 462E</b> Ø 2 - 3 - 4 - 5 - 6 - 7 - 8 - 9 - 10 - 11 - 12 - 13 - 14 - 15 16 - 17 - 18 - 19 - 20 - 21 - 22 - 23 - 24 - 25	35,05	52
467E.Ø	<b>OZ32 467E</b> Ø 2 - 3 - 4 - 5 - 6 - 7 - 8 - 9 - 10 - 11 - 12 - 13 - 14 - 15 16 - 17 - 18 - 19 - 20 - 21 - 22 - 23 - 24 - 25 - 26 - 27 28 - 29 - 30 - 31 - 32	43,7	60

Collet Set  
Spannzangensatz  
Pens Seti

131



ER UP Collet DIN 6499

Ultra Precision

Type  
ER UP

Form  
B



ER UP-Spannzange DIN 6499

ER UP Pens DIN 6499

Runout / Rundlauf / Salgi ≤ 0,005 mm

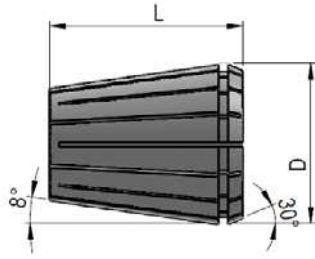

Order No. Bestell-Nr. Sipariş No.	Description   Bezeichnung   Açıklama Diameters   Durchmesser   Çaplar	D	L
4004E.Ø.UP	<b>ER8 4004E</b> Ø 1 - 1,5 - 2 - 2,5 - 3 - 3,5 - 4 - 4,5 - 5	8,5	13,6
4008E.Ø.UP	<b>ER11 4008E</b> Ø 1 - 1,5 - 2 - 2,5 - 3 - 3,5 - 4 - 4,5 - 5 - 5,5 - 6 - 6,5 - 7	11,5	18
426E.Ø.UP	<b>ER16 426E</b> Ø 1 - 2 - 3 - 4 - 5 - 6 - 7 - 8 - 9 - 10	17	27,5
428E.Ø.UP	<b>ER20 428E</b> Ø 1 - 2 - 3 - 4 - 5 - 6 - 7 - 8 - 9 - 10 - 11 - 12 - 13	21	31,5
430E.Ø.UP	<b>ER25 430E</b> Ø 1 - 2 - 3 - 4 - 5 - 6 - 7 - 8 - 9 - 10 - 11 - 12 - 13 - 14 15 - 16	26	34
470E.Ø.UP	<b>ER32 470E</b> Ø 1 - 2 - 3 - 4 - 5 - 6 - 7 - 8 - 9 - 10 - 11 - 12 - 13 - 14 15 - 16 - 17 - 18 - 19 - 20	33	40
472E.Ø.UP	<b>ER40 472E</b> Ø 1 - 2 - 3 - 4 - 5 - 6 - 7 - 8 - 9 - 10 - 11 - 12 - 13 - 14 15 - 16 - 17 - 18 - 19 - 20 - 21 - 22 - 23 - 24 - 25 - 26	41	46



Collet Set  
Spannzangensatz  
Pens Seti



## Collet Set in Box

Spannzangensatz im Koffer

Pens Takımı, Plastik Kutusu ile



Order No. Bestell-Nr. Sipariş No.	Description Bezeichnung Açıklama	B	L	H
4004E.105	4004E ER8 Ø 1-5 (9 Pcs.)	101	82	40
4008E.107	4008E ER11 Ø 1-7 (13 Pcs.)	101	82	40
426E.110	426E ER16 Ø 1-10 (10 Pcs.)	101	82	40
428E.113	428E ER20 Ø 1-13 (13 Pcs.)	101	82	40
430E.216	430E ER25 Ø 2-16 (15 Pcs.)	235	185	48
470E.320	470E ER32 Ø 3-20 (18 Pcs.)	275	230	83
472E.426	472E ER40 Ø 4-26 (23 Pcs.)	340	270	83
415E.216	415E OZ16 Ø 2-16 (15 Pcs.)	235	185	48
462E.225	462E OZ25 Ø 4-25 (16 Pcs.)	275	230	83
467E.432	467E OZ32 Ø 5-32 (16 Pcs.)	275	230	83

### Description / Bezeichnung / Açıklama

4004E	ER8	Ø 1-5	(9 Pcs.)	1-1,5-2-2,5-3-3,5-4-4,5-5
4008E	ER11	Ø 1-7	(13 Pcs.)	1-1,5-2-2,5-3-3,5-4-4,5-5-5,5-6-6,5-7
426E	ER16	Ø 1-10	(10 Pcs.)	1-2-3-4-5-6-7-8-9-10
428E	ER20	Ø 1-13	(13 Pcs.)	1-2-3-4-5-6-7-8-9-10-11-12-13
430E	ER25	Ø 2-16	(15 Pcs.)	2-3-4-5-6-7-8-9-10-11-12-13-14-15-16
470E	ER32	Ø 3-20	(18 Pcs.)	3-4-5-6-7-8-9-10-11-12-13-14-15-16-17-18-19-20
472E	ER40	Ø 4-26	(23 Pcs.)	4-5-6-7-8-9-10-11-12-13-14-15-16-17-18-19-20-21-22-23-24-25-26
415E	OZ16	Ø 2-16	(15 Pcs.)	2-3-4-5-6-7-8-9-10-11-12-13-14-15-16
462E	OZ25	Ø 4-25	(16 Pcs.)	4-5-6-7-8-9-10-11-12-14-16-18-20-22-24-25
467E	OZ32	Ø 5-32	(16 Pcs.)	5-6-8-10-12-14-16-18-20-22-24-25-26-28-30-32

# Gisstec®

TOOLING TECHNOLOGY



## ER Collet with Seal for Internal Cooling DIN 6499

ER Spannzange mit Abdichtung für IK DIN 6499

İçten Su Vermeli ER Pens DIN 6499

Type  
ER

Form  
NC



P max.= 70 bar

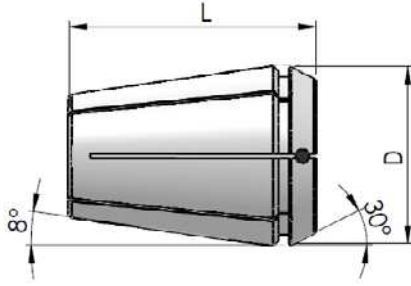

Order No. Bestell-Nr. Sipariş No.	Description   Bezeichnung   Açıklama Diameters   Durchmesser   Çaplar	D	L
426E.NC.Ø	<b>ER16 426E</b> Ø 2 - 3 - 4 - 5 - 6 - 7 - 8 - 9 - 10	17	27,5
428E.NC.Ø	<b>ER20 428E</b> Ø 2 - 3 - 4 - 5 - 6 - 7 - 8 - 9 - 10 - 11 - 12 - 13	21	31,5
430E.NC.Ø	<b>ER25 430E</b> Ø 2 - 3 - 4 - 5 - 6 - 7 - 8 - 9 - 10 - 11 - 12 - 13 - 14 15 - 16	26	34
470E.NC.Ø	<b>ER32 470E</b> Ø 3 - 4 - 5 - 6 - 7 - 8 - 9 - 10 - 11 - 12 - 13 - 14 15 - 16 - 17 - 18 - 19 - 20	33	40
472E.NC.Ø	<b>ER40 472E</b> Ø 4 - 5 - 6 - 7 - 8 - 9 - 10 - 11 - 12 - 13 - 14 15 - 16 - 17 - 18 - 19 - 20 - 21 - 22 - 23 - 24 - 25 - 26	41	46

ER Collet for Cooling through Spread Holes DIN 6499

ER Spannzanze mit 4 Schrägbohrungen für Kühlung DIN 6499

Alından Su Vermeli ER Pens DIN 6499

Type  
ER

Form  
NCD



P max.= 70 bar

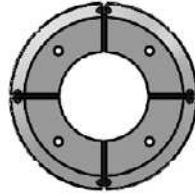
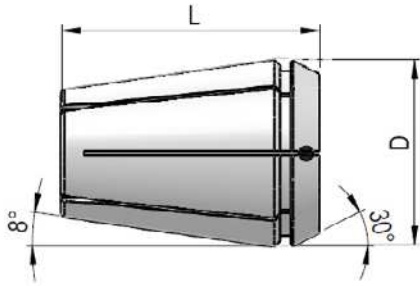

Order No. Bestell-Nr. Sipariş No.	Description   Bezeichnung   Açıklama Diameters   Durchmesser   Çaplar	D	L
426E.NCD.Ø	<b>ER16 426E</b> Ø 3 - 4 - 5 - 6 - 7 - 8 - 9 - 10	17	27,5
428E.NCD.Ø	<b>ER20 428E</b> Ø 3 - 4 - 5 - 6 - 7 - 8 - 9 - 10 - 11 - 12 - 13	21	31,5
430E.NCD.Ø	<b>ER25 430E</b> Ø 3 - 4 - 5 - 6 - 7 - 8 - 9 - 10 - 11 - 12 - 13 - 14 15 - 16	26	34
470E.NCD.Ø	<b>ER32 470E</b> Ø 3 - 4 - 5 - 6 - 7 - 8 - 9 - 10 - 11 - 12 - 13 - 14 15 - 16 - 17 - 18 - 19 - 20	33	40
472E.NCD.Ø	<b>ER40 472E</b> Ø 4 - 5 - 6 - 7 - 8 - 9 - 10 - 11 - 12 - 13 - 14 15 - 16 - 17 - 18 - 19 - 20 - 21 - 22 - 23 - 24 - 25 - 26	41	46

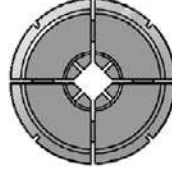
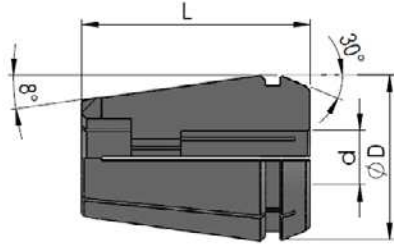

Order No. Bestell-Nr. Sipariş No.	Description Bezeichnung Açıklama	d		D	L
426E.G.3527	ER16 Ø 3,5	3,5	2,7	17	27,5
426E.G.4030	ER16 Ø 4	4	3	17	27,5
426E.G.4534	ER16 Ø 4,5	4,5	3,4	17	27,5
426E.G.649	ER16 Ø 6	6	4,9	17	27,5
426E.G.755	ER16 Ø 7	7	5,5	17	27,5
430E.G.3527	ER25 Ø 3,5	3,5	2,7	26	34
430E.G.4030	ER25 Ø 4	4	3	26	34
430E.G.4534	ER25 Ø 4,5	4,5	3,4	26	34
430E.G.649	ER25 Ø 6	6	4,9	26	34
430E.G.755	ER25 Ø 7	7	5,5	26	34
430E.G.862	ER25 Ø 8	8	6,2	26	34
430E.G.97	ER25 Ø 9	9	7	26	34
430E.G.108	ER25 Ø 10	10	8	26	34
430E.G.119	ER25 Ø 11	11	9	26	34
430E.G.129	ER25 Ø 12	12	9	26	34





ER Gewindebohrspannzange DIN 6499

ER Kılavuz Pensi DIN 6499

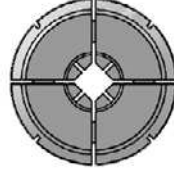
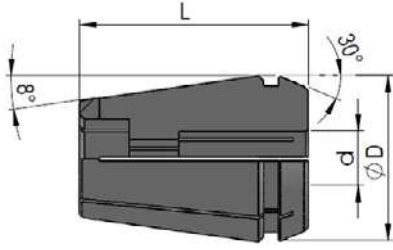

Order No. Bestell-Nr. Sipariş No.	Description Bezeichnung Açıklama	d		D	L
470E.G.4534	ER32 Ø 4,5	4,5	3,4	33	40
470E.G.649	ER32 Ø 6	6	4,9	33	40
470E.G.755	ER32 Ø 7	7	5,5	33	40
470E.G.862	ER32 Ø 8	8	6,2	33	40
470E.G.97	ER32 Ø 9	9	7	33	40
470E.G.108	ER32 Ø 10	10	8	33	40
470E.G.119	ER32 Ø 11	11	9	33	40
470E.G.129	ER32 Ø 12	12	9	33	40
470E.G.1411	ER32 Ø 14	14	11	33	40
470E.G.1612	ER32 Ø 16	16	12	33	40
472E.G.649	ER40 Ø 6	6	4,9	41	46
472E.G.755	ER40 Ø 7	7	5,5	41	46
472E.G.862	ER40 Ø 8	8	6,2	41	46
472E.G.97	ER40 Ø 9	9	7	41	46
472E.G.108	ER40 Ø 10	10	8	41	46
472E.G.119	ER40 Ø 11	11	9	41	46
472E.G.129	ER40 Ø 12	12	9	41	46
472E.G.1411	ER40 Ø 14	14	11	41	46
472E.G.1612	ER40 Ø 16	16	12	41	46
472E.G.18145	ER40 Ø 18	18	14,5	41	46
472E.G.2016	ER40 Ø 20	20	16	41	46

## Straight Collet

### Reduzierhülse

### Silindirik Pens

For Hydraulic and Ultra-Clamp Chuck  
Für Hydrodehn- und Ultra-Clamp-Futter  
Hidrolik ve Ultra-Clamp Tutucu için

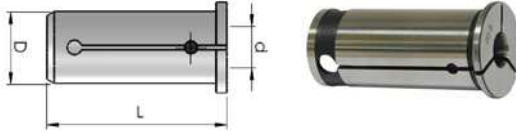

For Milling Chuck  
Für Kraftspannfutter  
Bilyalı Pens Başlığı için

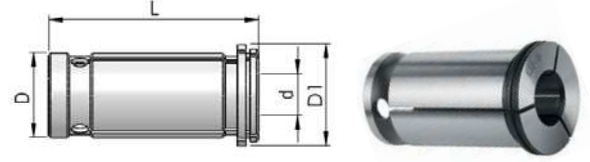

Order No. Bestell-Nr. Sipariş No.	Description Bezeichnung Açıklama	d	D	L
412.30.03	12-06 UP	3	12	44
412.30.04	12-04 UP	4	12	44
412.30.05	12-05 UP	5	12	44
412.30.06	12-06 UP	6	12	44
412.30.08	12-08 UP	8	12	44
420.30.03	20-03 UP	3	20	53
420.30.04	20-04 UP	4	20	53
420.30.05	20-05 UP	5	20	53
420.30.06	20-06 UP	6	20	53
420.30.08	20-08 UP	8	20	53
420.30.10	20-10 UP	10	20	53
420.30.12	20-12 UP	12	20	53
420.30.14	20-14 UP	14	20	53
420.30.16	20-16 UP	16	20	53
432.30.06	32-06 UP	6	32	63
432.30.08	32-08 UP	8	32	63
432.30.10	32-10 UP	10	32	63
432.30.12	32-12 UP	12	32	63
432.30.14	32-14 UP	14	32	63
432.30.16	32-16 UP	16	32	63
432.30.18	32-18 UP	18	32	63
432.30.20	32-20 UP	20	32	63
432.30.25	32-25 UP	25	32	63

Order No. Bestell-Nr. Sipariş No.	Description Bezeichnung Açıklama	d	D	D1	L
420.03.06	20-06 K	6	20	25	50
420.03.08	20-08 K	8	20	25	50
420.03.10	20-10 K	10	20	25	50
420.03.12	20-12 K	12	20	25	50
420.03.16	20-16 K	16	20	25	50
432.03.06	32-06 K	6	32	37	60
432.03.08	32-08 K	8	32	37	60
432.03.10	32-10 K	10	32	37	60
432.03.12	32-12 K	12	32	37	60
432.03.16	32-16 K	16	32	37	60
432.03.20	32-20 K	20	32	37	60
432.03.25	32-25 K	25	32	37	60

Sealed | Abgedichtet | Lastikli

## Reduction Sleeve

### Reduzierhülse

### Redüksiyon

For VDI Holders

Für VDI-Aufnahmen

VDI Tutucular için Kater Redüksiyonu

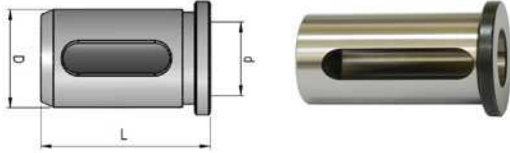

For Coolant Feeder

Für Kühlmittelzuführung

Dıştan Soğ. Takımlar için

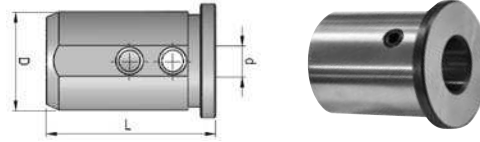

Order No. Bestell-Nr. Sipariş No.	Description Bezeichnung Açıklama	d	D	L
232.32.106	32-06 V	6	32	70
232.32.108	32-08 V	8	32	70
232.32.110	32-10 V	10	32	70
232.32.112	32-12 V	12	32	70
232.32.116	32-16 V	16	32	70
232.32.120	32-20 V	20	32	70
232.32.125	32-25 V	25	32	70
232.40.106	40-06 V	6	40	80
232.40.108	40-08 V	8	40	80
232.40.110	40-10 V	10	40	80
232.40.112	40-12 V	12	40	80
232.40.116	40-16 V	16	40	80
232.40.120	40-20 V	20	40	80
232.40.125	40-25 V	25	40	80
232.40.132	40-32 V	32	40	80

Order No. Bestell-Nr. Sipariş No.	Description Bezeichnung Açıklama	d	D	L
230.32.106	32-06 D	6	32	55
230.32.108	32-08 D	8	32	55
230.32.110	32-10 D	10	32	55
230.32.112	32-12 D	12	32	55
230.32.116	32-16 D	16	32	55
230.32.120	32-20 D	20	32	55
230.32.125	32-25 D	25	32	55
230.40.110	40-10 D	10	40	55
230.40.112	40-12 D	12	40	55
230.40.116	40-16 D	16	40	55
230.40.120	40-20 D	20	40	55
230.40.125	40-25 D	25	40	60
230.40.132	40-32 D	32	40	65

## Clamping Nut OZ DIN 6388

Spannmutter OZ DIN 6388

Kapak OZ DIN 6388

Type  
OZ

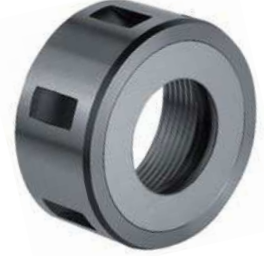
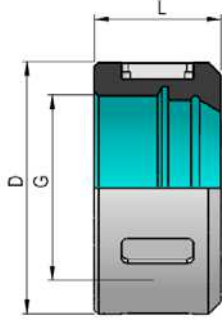

Order No. Bestell-Nr. Sipariş No.	Description Bezeichnung Açıklama	OZ	D	L	G	Max. Torque
203.01.116	415	16	43	24	M33x1,5	85 Nm
203.01.125	462	25	60	30	M48x2	140 Nm
203.01.132	467	32	72	33,5	M60x2,5	170 Nm

## Clamping Nut ER DIN 6499

Spannmutter ER DIN 6499

Kapak ER DIN 6499

Type  
ER

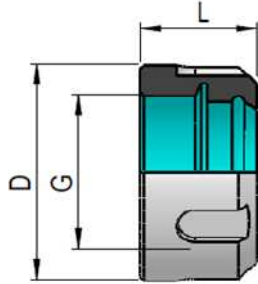

Order No. Bestell-Nr. Sipariş No.	Description Bezeichnung Açıklama	D	L	G	Max. Torque
203.02.110	ER16	32	17	M22X1,5	50 Nm
203.02.113	ER20	35	19	M25X1,5	75 Nm
203.02.116	ER25	42	20	M32X1,5	85 Nm
203.02.120	ER32	50	22,5	M40X1,5	105 Nm
203.02.126	ER40	63	25,5	M50X1,5	150 Nm

## Clamping Nut ER Mini

Spannmutter ER Mini

Kapak ER Mini

Type  
ER Mini

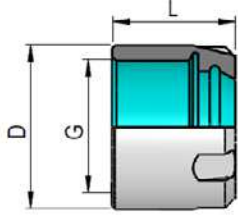

Order No. Bestell-Nr. Sipariş No.	Description Bezeichnung Açıklama	D	L	G	Max. Torque
203.2M.105	ER 8 Mini	12	10,8	M10X0,75	8 Nm
203.2M.107	ER 11 Mini	16	12	M13X0,75	18 Nm
203.2M.110	ER 16 Mini	22	18	M19X1	28 Nm
203.2M.113	ER 20 Mini	28	19	M24X1	35 Nm
203.2M.116	ER 25 Mini	35	20	M30X1	39 Nm

## Clamping Nut ER Hexagonal

Spannmutter ER 6-Kant

ER Kapak 6 Köşe

Type  
ER

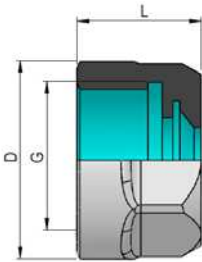

Order No. Bestell-Nr. Sipariş No.	Description Bezeichnung Açıklama	D	L	G	Max. Torque
204.02.207	ER11 X6	19	14	M14X0,75	25 Nm
204.02.210	ER16 X6	28	17,5	M22X1,5	50 Nm
204.02.213	ER20 X6	34	19	M25X1,5	75 Nm

## Zero-Zero Clamping Nut

Zero-Zero Spannmutter

Salgı Sıfırlama Kapağı

Type  
ER

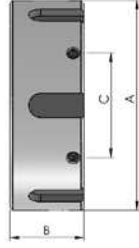

Order No. Bestell-Nr. Sipariş No.	Description Bezeichnung Açıklama	A	B	G
205.02.110	ER16	34	21	M22 x 1,5
205.02.116	ER25	50	22	M32 x 1,5
205.02.120	ER32	63	23	M40 x 1,5
205.02.126	ER40	78	28	M50 x 1,5

## ER Clamping Nut with Rotating Ring DIN 6499

ER Spannmutter mit Kugellager DIN 6499

Bilyalı ER Kapak DIN 6499

Type  
ER

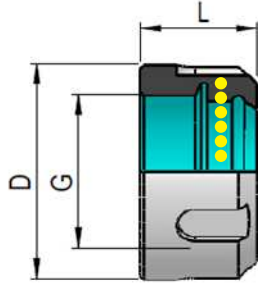

Order No. Bestell-Nr. Sipariş No.	Description Bezeichnung Açıklama	D	L	G
203.02.110	ER16	32	17	M22X1,5
203.02.113	ER20	35	19	M25X1,5
203.02.116	ER25	42	20	M32X1,5
203.02.120	ER32	50	22,5	M40X1,5
203.02.126	ER40	63	25,5	M50X1,5

## Externally Threaded Nut - Hexagonal

Spannmutter mit Aussengewinde - Hexagonal

Dıştan Sıkmalı Kapak - 6 Köşe

Type  
ER

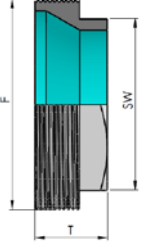

Order No. Bestell-Nr. Sipariş No.	Description Bezeichnung Açıklama	F	T	SW
207.02.107	ERX11A	M18x1	9	15
207.02.110	ERX16A	M24x1	12	19
207.02.113	ERX20A	M28x1,5	13	22
207.02.116	ERX25A	M32x1,5	16,5	27
207.02.120	ERX32A	M40x1,5	19	32
207.02.126	ERX40A	M50x1,5	17	42

## Externally Threaded Nut

Spannmutter mit Außengewinde

Dıştan Sıkmalı Kapak

Type  
ER

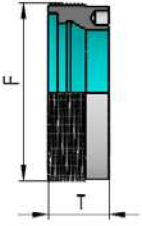

Order No. Bestell-Nr. Sipariş No.	Description Bezeichnung Açıklama	F	T
207.02.207	ERX11A	M18x1	6
207.02.210	ERX16A	M24x1	8
207.02.213	ERX20A	M28x1,5	11
207.02.216	ERX25A	M32x1,5	12
207.02.220	ERX32A	M40x1,5	14
207.02.226	ERX40A	M50x1,5	18

## Wrench DIN 1810A

Hakenschlüssel DIN 1810A

Ay Anahtarı DIN 1810A



Order No. Bestell-Nr. Sipariş No.	Description Bezeichnung Açıklama	D
202.01.116	45-50	43
202.01.125	58-62	60
202.01.132	68-75	72

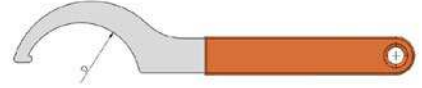

## Wrench ER

Spannschlüssel ER

ER Ay Anahtarı



Order No. Bestell-Nr. Sipariş No.	Description Bezeichnung Açıklama	D
202.02.110	ER16	32
202.02.113	ER20	35
202.02.116	ER25	42
202.02.120	ER32	50
202.02.126	ER40	63

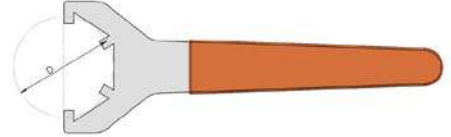



## Wrench for Mini ER

Spanschlüssel für Mini ER

ER Mini Ay Anahtarı



Order No. Bestell-Nr. Sipariş No.	Description Bezeichnung Açıklama	D
202.2M.105	ER 8 Mini	12
202.2M.107	ER11 Mini	16
202.2M.110	ER16 Mini	22
202.2M.113	ER20 Mini	28
202.2M.116	ER25 Mini	35



## Torque Wrench for ER and ER Mini Nuts

Drehmomentschlüssel für ER und ER-Mini Spannmutter

Tork Anahtarı, ER ve ER Mini Kapaklar için



Order No. Bestell-Nr. Sipariş No.	Description Bezeichnung Açıklama	Nut Spannmutter Kapak	D	Key Schlüssel Anahtar	L	Nm	Nm
202.15.305	ER 8 Mini		12		117	8	
202.15.307	ER 11 Mini		16		120	18	
202.15.310	ER 16 Mini		22		175	28	
202.15.313	ER 20 Mini		28		180	35	
202.15.410	ER 16		32		380	25-35	45-55
202.15.413	ER 20		35		380	30-40	60-70
202.15.416	ER 25		42		400	45-55	80-90
202.15.420	ER 32		50		400	65-70	120-130
202.15.426	ER 40		63		450	110-120	190-200

## Tapping Collet with Clutch

Einsatz mit Rutschkupplung

Kılavuz Tutucu - Emniyetli

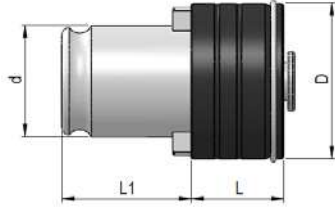

Order No. Bestell-Nr. Sipariş No.	Description Bezeichnung Açıklama	d	D	L	L1	M	Şaft	□	DIN
116.11.3527	KTE1 3,5 M3	19	32	25	21,5	M 3	3,5	2,7	371
116.11.4534	KTE1 4,5 M4	19	32	25	21,5	M 4	4,5	3,4	371
116.11.649	KTE1 6 M5	19	32	25	21,5	M 5	6	4,9	371
116.11.649	KTE1 6 M6	19	32	25	21,5	M 6	6	4,9	371
116.11.862	KTE1 8 M8	19	32	25	21,5	M 8	8	6,2	371
116.11.755	KTE1 7 M10	19	32	25	21,5	M10	7	5,5	376
116.11.108	KTE1 10 M10	19	32	25	21,5	M10	10	8	371
116.11.97	KTE1 9 M12	19	32	25	21,5	M12	9	7	376
116.11.119	KTE1 11 M14	19	32	25	21,5	M14	11	9	376
116.12.649	KTE2 6 M6	31	50	34	35	M 6	6	4,9	371
116.12.862	KTE2 8 M8	31	50	34	35	M 8	8	6,2	371
116.12.755	KTE2 7 M10	31	50	34	35	M10	7	5,5	376
116.12.108	KTE2 10 M10	31	50	34	35	M10	10	8	371
116.12.97	KTE2 9 M12	31	50	34	35	M12	9	7	376
116.12.119	KTE2 11 M14	31	50	34	35	M14	11	9	376
116.12.129	KTE2 12 M16	31	50	34	35	M16	12	9	376
116.12.1411	KTE2 14 M18	31	50	34	35	M18	14	11	376
116.12.1612	KTE2 16 M20	31	50	34	35	M20	16	12	376
116.12.1814	KTE2 18 M24	31	50	34	35	M24	18	14,5	376
116.13.97	KTE3 9 M12	48	72	45	55,5	M12	9	7	376
116.13.119	KTE3 11 M14	48	72	45	55,5	M14	11	9	376
116.13.129	KTE3 12 M16	48	72	45	55,5	M16	12	9	376
116.13.1411	KTE3 14 M18	48	72	45	55,5	M18	14	11	376
116.13.1612	KTE3 16 M20	48	72	45	55,5	M20	16	12	376
116.13.1814	KTE3 18 M24	48	72	45	55,5	M24	18	14,5	376
116.13.2016	KTE3 20 M27	48	72	45	55,5	M27	20	16	376
116.13.2218	KTE3 22 M30	48	72	45	55,5	M30	22	18	376
116.13.2520	KTE3 25 M33	48	72	45	55,5	M33	25	20	376
116.13.2822	KTE3 28 M36	48	72	45	55,5	M36	28	22	376

## Tapping Collet without Clutch

Einsatz ohne Rutschkupplung

Kılavuz Tutucu - Emniyetsiz

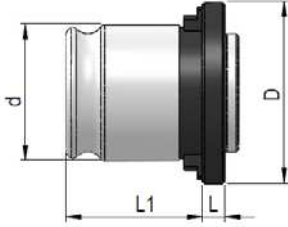

Order No. Bestell-Nr. Sipariş No.	Description Bezeichnung Açıklama	d	D	L	L1	M	Şaft	□	DIN
116.01.2821	KT1 2,8 M2	19	30	7	21,5	M 2	2,8	2,1	371
116.01.3527	KT1 3,5 M3	19	30	7	21,5	M 3	3,5	2,7	371
116.01.4534	KT1 4,5 M4	19	30	7	21,5	M 4	4,5	3,4	371
116.01.649	KT1 6 M6	19	30	7	21,5	M 6	6	4,9	371
116.01.862	KT1 8 M8	19	30	7	21,5	M 8	8	6,2	371
116.01.755	KT1 7 M10	19	30	7	21,5	M10	7	5,5	376
116.01.108	KT1 10 M10	19	30	7	21,5	M10	10	8	371
116.01.97	KT1 9 M12	19	30	7	21,5	M12	9	7	376
116.01.119	KT1 11 M14	19	30	7	21,5	M14	11	9	376
116.02.649	KT2 6 M6	31	46	11	35	M 6	6	4,9	371
116.02.755	KT2 7 M10	31	46	11	35	M10	7	5,5	376
116.02.862	KT2 8 M8	31	46	11	35	M 8	8	6,2	371
116.02.97	KT2 9 M12	31	46	11	35	M12	9	7	376
116.02.108	KT2 10 M10	31	46	11	35	M10	10	8	371
116.02.119	KT2 11 M14	31	46	11	35	M14	11	9	376
116.02.129	KT2 12 M16	31	46	11	35	M16	12	9	376
116.02.1411	KT2 14 M18	31	46	11	35	M18	14	11	376
116.02.1612	KT2 16 M20	31	46	11	35	M20	16	12	376
116.02.1814	KT2 18 M24	31	46	11	35	M24	18	14,5	376
116.03.119	KT3 11 M14	48	68	14	55,5	M14	11	9	376
116.03.129	KT3 12 M16	48	68	14	55,5	M16	12	9	376
116.03.1411	KT3 14 M18	48	68	14	55,5	M18	14	11	376
116.03.1612	KT3 16 M20	48	68	14	55,5	M20	16	12	376
116.03.1814	KT3 18 M24	48	68	14	55,5	M24	18	14,5	376
116.03.2016	KT3 20 M27	48	68	14	55,5	M27	20	16	376
116.03.2218	KT3 22 M30	48	68	14	55,5	M30	22	18	376
116.03.2520	KT3 25 M33	48	68	14	55,5	M33	25	20	376
116.03.2822	KT3 28 M36	48	68	14	55,5	M36	28	22	376

## Adapter for Synchro-Tapping Chuck

Einsatz für Synchro-Gewindeschneidfutter

Senkronize Kılavuz Çekme Adaptörü

Order No. Bestell-Nr. Sipariş No.	Description Bezeichnung Açıklama	d	D	L	L1
126.02.110	M3-M12 ER16	20	28	24	37
126.02.116	M6-M20 ER25	32	42	28	52
126.02.126	M14-M33 ER40	50	63	32	75
126.02.210	M3-M12 ER16	20	28	55	38
126.02.216	M6-M20 ER25	32	42	86	63
126.02.226	M14-M33 ER40	50	63	95	73

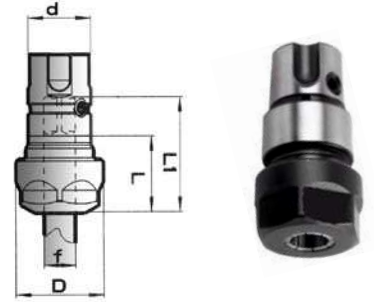

## Shrink Extension

Schrumpfverlängerung

Shrink Uzatma

Order No. Bestell-Nr. Sipariş No.	Description Bezeichnung Açıklama	D	d1	d2	l1	l2
612.25.403	d12-160 Ø3	12	3	8	160	10
612.25.404	d12-160 Ø4	12	4	8	160	12
612.25.406	d12-160 Ø6	12	6	8	160	12
616.25.403	d16-160 Ø3	16	3	10	160	9
616.25.404	d16-160 Ø4	16	4	10	160	12
616.25.405	d16-160 Ø5	16	5	10	160	15
616.25.406	d16-160 Ø6	16	6	10	160	28
620.25.405	d20-160 Ø5	20	5	14	160	15
620.25.406	d20-160 Ø6	20	6	14	160	28
620.25.408	d20-160 Ø8	20	8	14	160	34
625.25.405	d25-160 Ø8	25	8	19	160	34
625.25.406	d25-160 Ø10	25	10	20	160	42
625.25.408	d25-160 Ø12	25	12	20	160	47
625.25.406	d25-160 Ø14	25	14	20	160	47
625.25.408	d25-160 Ø16	25	16	22	160	50
632.25.410	d32-160 Ø10	32	10	27	160	42
632.25.412	d32-160 Ø12	32	12	27	160	47
632.25.414	d32-160 Ø14	32	14	27	160	47
632.25.416	d32-160 Ø16	32	16	27	160	50
632.25.420	d32-160 Ø20	32	20	27	160	52

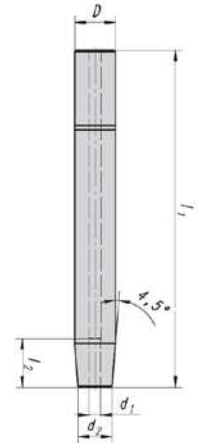

## Collet Chuck with Cylindrical Shank

DIN 6499

Form  
ER

Spannzangenfutter mit Zylinderschaft

Silindirik Şaftlı Pens Başlıkları

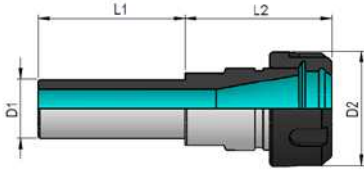

Order No. Bestell-Nr. Sipariş No.	Description Bezeichnung Açıklama	D1	D2	L2	L1
610.2M.205	d10-100 ER8 Mini 1-5	10	12	20	100
612.2M.207	d12-100 ER11 Mini 1-7	12	16	30	100
616.2M.307	d16-160 ER11 Mini 1-7	16	16	22	160
616.02.110	d16-60 ER16 1-10	16	28	35	60
616.02.310	d16-160 ER16 1-10	16	28	35	160
620.02.116	d20-70 ER25 2-16	25	42	45	70
620.02.316	d20-160 ER25 2-16	25	42	45	160
625.02.116	d25-70 ER25 2-16	25	42	45	70
625.02.316	d25-160 ER25 2-16	25	42	45	160
632.02.120	d32-70 ER32 3-20	32	50	53	70
632.02.320	d32-160 ER32 3-20	32	50	53	160
640.02.126	d40-80 ER40 4-26	40	63	56	80

## Tapping Chuck with Cylindrical Shank

DIN 1835

Form  
B-E

Gewindeschneidfutter mit Zylinderschaft

Silindirik Şaftlı Kılavuz Çekme Başlıkları



Order No. Bestell-Nr. Sipariş No.	Description Bezeichnung Açıklama	d	D	D1	L	L1
620.16.120	Ø20 M3-M12	19	38	20	50	41
620.16.125	Ø25 M3-M12	19	38	25	56	41
620.16.132	Ø32 M3-M12	19	38	32	61	41
620.16.140	Ø40 M3-M12	19	38	40	72	41
620.16.225	Ø25 M5-M20	31	55	25	56	63
620.16.232	Ø32 M5-M20	31	55	32	61	63
620.16.240	Ø40 M5-M20	31	55	40	72	63

## Drill Chuck

Bohrfutter

Supra Mandren

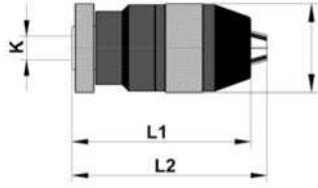

Order No. Bestell-Nr. Sipariş No.	Description Bezeichnung Açıklama	K	L1	L2	D
240.14.12	B12 0-10		79	86	40
240.14.16	B16 1-13		93	103	47
240.14.26	B16 3-16		93	103	47
240.14.18	B18 3-16		95	105	52

## Clamping Screw

DIN 1835 B

Spannschraube

Veldon Sıkma Civatası

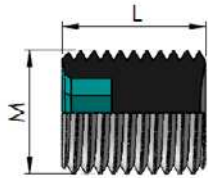

Order No. Bestell-Nr. Sipariş No.	Description Bezeichnung Açıklama	M	L
210.04.06	d 6	M6	10
210.04.08	d 8	M8	10
210.04.10	d10	M10	12
210.04.12	d12	M12	16
210.04.16	d16	M14	16
210.04.20	d20	M16	16
210.04.25	d25	M18x2	20
210.04.32	d32	M20x2	20
210.04.40	d40	M20x2	20

Pull Stud

DIN 69872

Form  
A



Anzugsbolzen

Çektirme Civatası

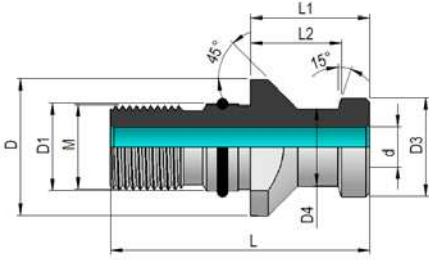

Order No. Bestell-Nr. Sipariş No.	Description Bezeichnung Açıklama	D	D1	D3	D4	L	L1	L2	M	d
140.20.101	SK40 DIN69872-A M16	23	17	19	14	54	26	20	M16	7
150.20.101	SK50 DIN69872-A M24	36	25	28	21	74	34	25	M24	11,5
140.20.115	MAS BT40 OKUMA M16	23	17	19	14	54	29	23	M16	7
⊛ 140.20.120	MAS BT40 MORISEIKI M16	23	17	19	14	54	29	23	M16	7

- ⊛ Internal O-Ring  
Innen liegender O-Ring  
Delikliçi O-Ringli

Pull Stud

DIN 69872

Form  
B



Anzugsbolzen

Çektirme Civatası

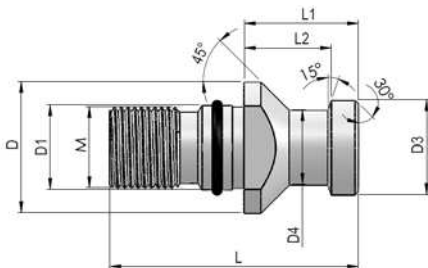

Order No. Bestell-Nr. Sipariş No.	Description Bezeichnung Açıklama	D	D1	D3	D4	L	L1	L2	M
140.20.111	SK40 DIN69872-B M16	23	17	19	14	54	26	20	M16
150.20.111	SK50 DIN69872-B M24	36	25	28	21	74	34	25	M24

**Pull Stud**

MAS 403 BT

Anzugsbolzen  
Çektirme Civatası

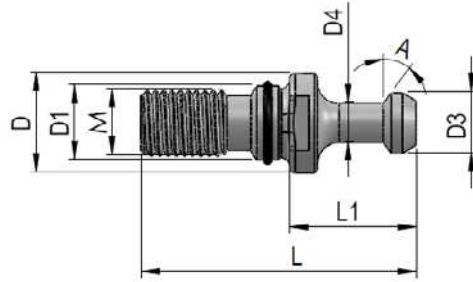

Order No. Bestell-Nr. Sipariş No.	Description Bezeichnung Açıklama	D	D1	D3	D4	L	L1	A	M
330.20.101	BT30 M12 30°	16,5	12,5	11	7	43	23	30°	M12
330.20.102	BT30 M12 45°	16,5	12,5	11	7	43	23	45°	M12
340.20.101	BT40 M16 30°	23	17	15	10	60	35	30°	M16
340.20.102	BT40 M16 45°	23	17	15	10	60	35	45°	M16
340.20.103	BT40 M16 90°	23	17	15	10	60	35	90°	M16
350.20.101	BT50 M24 30°	38	25	23	17	85	45	30°	M24
350.20.102	BT50 M24 45°	38	25	23	17	85	45	45°	M24
350.20.103	BT50 M24 90°	38	25	23	17	85	45	90°	M24

**Pull Stud**

MAS 403 BT

Anzugsbolzen  
Çektirme Civatası

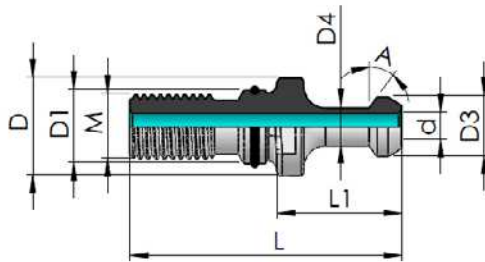

Order No. Bestell-Nr. Sipariş No.	Description Bezeichnung Açıklama	D	D1	D3	D4	L	L1	A	M	d
340.20.111	BT40 M16 30°	23	17	15	10	60	35	30°	M16	3
340.20.112	BT40 M16 45°	23	17	15	10	60	35	45°	M16	3
340.20.113	BT40 M16 90°	23	17	15	10	60	35	90°	M16	3
350.20.111	BT50 M24 30°	38	25	23	17	85	45	30°	M24	6
350.20.112	BT50 M24 45°	38	25	23	17	85	45	45°	M24	6
350.20.113	BT50 M24 90°	38	25	23	17	85	45	90°	M24	6



Pull Stud

ANSI-CAT MAZAK



Anzugsbolzen

Çektirme Civatası

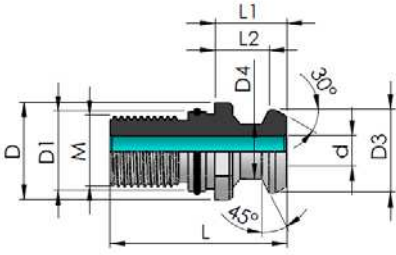

Order No. Bestell-Nr. Sipariş No.	Description Bezeichnung Açıklama	D	D1	D3	D4	L	L1	L2	M	d
440.20.101	ANSI-CAT MAZAK M16	22	17	18,79	12,5	41,25	16,25	11,17	M16	7
450.20.101	ANSI-CAT MAZAK M24	35,6	25	28,95	20,82	65,4	25,4	17,78	M24	10
440.20.115	MAS BT40 MAZAK M16	22	17	18,79	12,44	44,10	19,10	14,10	M16	7

Pull Stud

ISO 7388-B



Anzugsbolzen

Çektirme Civatası

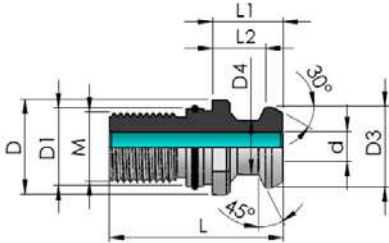

Order No. Bestell-Nr. Sipariş No.	Description Bezeichnung Açıklama	D	D1	D3	D4	L	L1	L2	M	d
440.20.111	ISO 7388-B M16	22,5	17	18,9	12,9	44,5	16,4	11,1	M16	7,3
450.20.111	ISO 7388-B M24	37	25	29,1	19,6	65,5	25,5	17,9	M24	11,5

## Clutch Drive Ring DIN 6366

Mitnehmerring DIN 6366

Tırnaklı Pul DIN 6366



Order No. Bestell-Nr. Sipariş No.	d	D	a	b	h
212.10.116	16	32	10	8	5
212.10.122	22	40	12	10	5,6
212.10.127	27	48	12	12	6,3
212.10.132	32	58	14	14	7
212.10.140	40	70	14	16	8

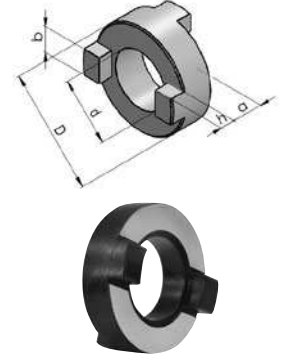

## Draw-in Bolt DIN 6367

Fräseranzugsschraube DIN 6367

Kelebek Civata DIN 6367



Order No. Bestell-Nr. Sipariş No.	D	L1	L2	M
210.10.116	20	16	6	M 8
210.10.122	28	18	7	M10
210.10.127	35	22	8	M12
210.10.132	42	26	9	M16
210.10.140	52	30	10	M20

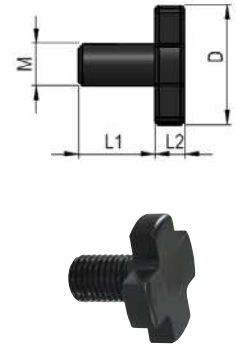

## Wrench DIN 6368

Spannschlüssel DIN 6368

Kelebek Civata Anahtarı DIN 6368



Order No. Bestell-Nr. Sipariş No.	Description Bezeichnung Açıklama	D
202.10.116	M 8	16
202.10.122	M10	22
202.10.127	M12	27
202.10.132	M16	32
202.10.140	M20	40

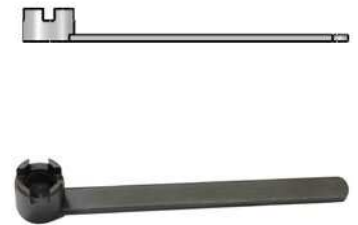

## Coolant Tube, for HSK

Kühlmittelrohr, für HSK

Soğutma Suyu Ünitesi, HSK için

Order No. Bestell-Nr. Sipariş No.	Description Bezeichnung Açıklama	HSK	D	L	L1	M
63A.20.205	HSK 63	63A	12	36,6	11,5	18x1
100A.20.205	HSK100	100A	16	44	15,5	24x1,5

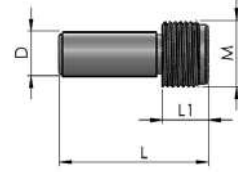

## Key for Coolant Tubes

Schlüssel für Kühlmitelrohre

Soğutma Ünitesi Anahtarı

Order No. Bestell-Nr. Sipariş No.	Description Bezeichnung Açıklama	D
63A.20.202	HSK63	16,5
100A.20.202	HSK100	22



## Taper Wiper

Kegelwischer

Konik Temizleme

Order No. Bestell-Nr. Sipariş No.	Description Bezeichnung Açıklama
226.01.101	MK1
226.01.102	MK2
226.01.103	MK3
226.01.104	MK4
226.01.105	MK5
226.02.130	SK30
226.02.140	SK40
226.02.150	SK50
226.03.163	HSK63
226.03.100	HSK100



## 3D Edge Sensor

3D-Kantentaster

3D Saatli Sıfırlama



Order No. Bestell-Nr. Sipariş No.	Description Bezeichnung Açıklama
225.05.220	3D Edge Sensor



## Probe Tip for 3D Sensor

Tasteinsatz für 3D-Taster

3D Saatli Sıfırlama Ucu



Order No. Bestell-Nr. Sipariş No.	Description Bezeichnung Açıklama	L	D
225.06.225	Tip short / kurz / kısa	25	4
225.06.265	Tip long / lang / uzun	65	8



## Zero Setter Mechanical

Nulleinstellgerät Mechanisch

Saatli Sıfırlama



Order No. Bestell-Nr. Sipariş No.	Description Bezeichnung Açıklama	D	L	L1
225.04.150	Mechanical	65	50	49.5
225.04.250	Mechanical with magnet	65	50	49.5

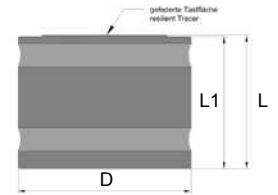

## Zero Setter Optical

Nulleinstellgerät Optisch

Işıklı Sıfırlama



Order No. Bestell-Nr. Sipariş No.	Description Bezeichnung Açıklama	d	D	L
225.02.160	Optical	19	39	60
225.02.260	Optical with magnet	19	39	60

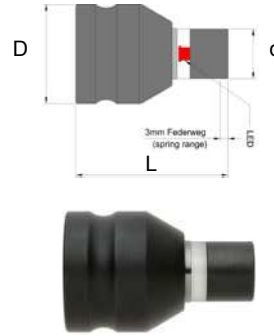

## Edge Finder Mechanical

Kantentaster Mechanisch

Mekanik Prop



Order No. Bestell-Nr. Sipariş No.	Description Bezeichnung Açıklama	d	D	L
225.03.100	10 Mechanical	-	10	84
225.03.104	10-4 Mechanical	4	10	94

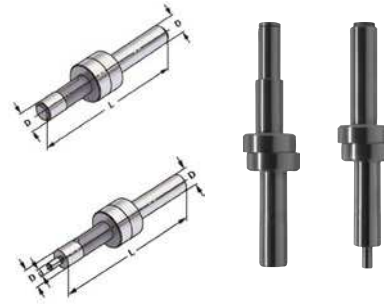

## Edge Finder Optical & Acoustic

Kantentaster Optisch & Akustisch

Elektronik Işıklı & Sesli Prop



Order No. Bestell-Nr. Sipariş No.	Description Bezeichnung Açıklama	d	D	L	L1
225.01.216	2D-16 Optical	10	16	99	35
225.01.220	2D-20 Optical	10	20	94	45
225.01.316	3D-16 Optical	10	16	111	35
225.01.320	3D-20 Optical	10	20	106	45
225.11.225	2D-20 Optical & Acoustic	10	20	119	35
225.11.325	3D-20 Optical & Acoustic	10	20	131	45



## Fast-mounting Assembly Block Steel, Universal

Schnellmontageblock aus Stahl, Universal

Çelik Montaj Aparatı, Üiversal



Order No. Bestell-Nr. Sipariş No.	Description Bezeichnung Açıklama
228.04.200	SK40 - ISO40 - BT40 - HSK63
228.04.250	SK50 - ISO50 - BT50 - HSK100



- For clamping of SK - ISO - BT- HSK  
Zur Aufnahme von SK - ISO - BT- HSK  
SK - ISO - BT- HSK Takımların tamamında kullanılabilir
- 45 ° and 90 ° - can be used in 3 different positions  
45 ° und 90 ° - verschiedene Positionen verwendbar  
45 ° ve 90 ° - pozisyonda kullanılabilir özellikle



## Tightening Fixture Aluminium

Montageblock aus Aluminium

Montaj Aparatı, Alüminyum



Order No. Bestell-Nr. Sipariş No.	Description Bezeichnung Açıklama
228.01.130	SK30
228.01.140	SK40
228.01.150	SK50



## Benchtop Tool Shelf

Tischwerkzeugregal

Masaüstü Takım Sehpaları



Order No. Bestell-Nr. Sipariş No.	Description Bezeichnung Açıklama	Insert Einsätze Takım Adedi	H	B	T
270.100	HSK 100	16	300	600	500
270.150	SK 30-40-50 HSK 32-40-50-63-80 VDI 30-40-50	16	300	600	500

## Tool Transport Trolley

Werkzeugtransportwagen

Takım Arabası



Order No. Bestell-Nr. Sipariş No.	Description Bezeichnung Açıklama	Insert Einsätze Takım Adedi	H	B	T
272.100	HSK 100	50	1200	615	550
✳ 272.150	SK 30-40-50 HSK 32-40-50-63-80 VDI 30-40-50	50	1200	615	550

- ✳ SK 30-40-50  
HSK 16-32-40-50-63-80  
VDI 30-40-50

All these toolholder types can be stored on the same benchtop tool shelf.  
The sockets are modular and can be resized according to taper size.

Diese Typen von Werkzeughalter können auf dasselbe Tischwerkzeugregal gestellt werden.  
Die Einsätze sind modular und haben eine einstellbare Größe.

Takımların tamamı aynı takım arabasında kullanılabilir.  
Takım yuvaları modülerdir ve her konik tipine göre ayarlanabilir.